

Rear Quarter Trim Panel (76.13.12)

Removal

- 1 . Fold down the rear seat backrest.
- 2 . Release the door aperture weatherstrip.

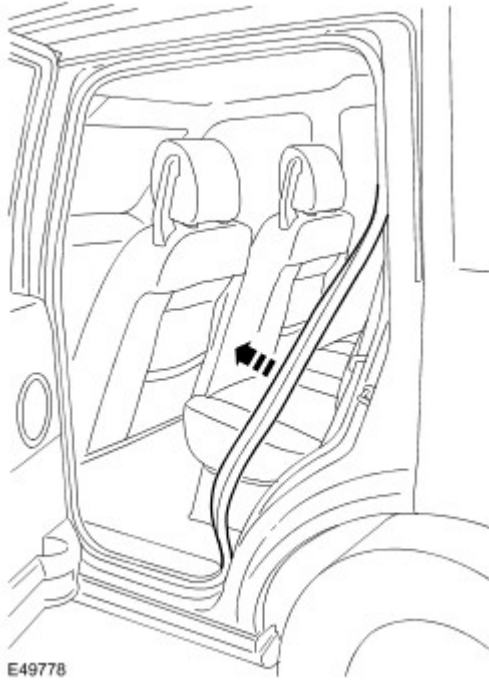

- 3 . Release the safety belt anchor.
▶ Remove and discard the bolt.



- 4 . Release the tailgate aperture seal.

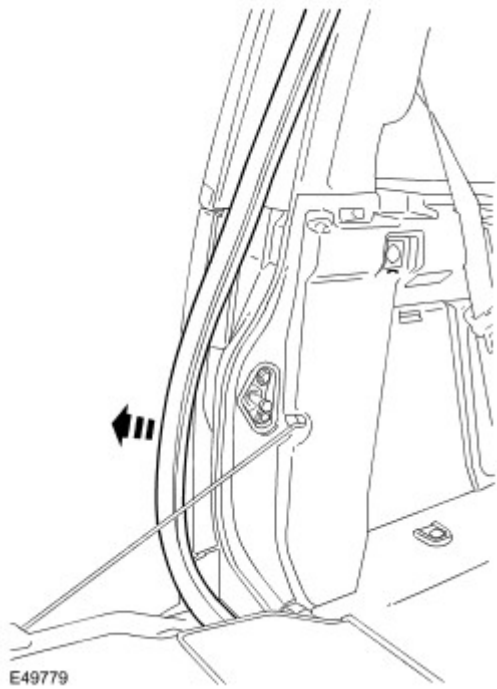

5 . Remove the support spigot from the tailgate.

▶ Release the clip.

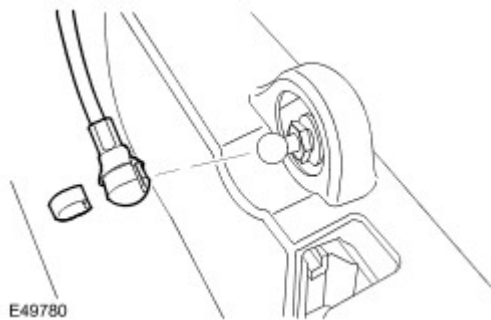

6 . Remove the rear quarter trim panel.

▶ Remove the Torx screw.

▶ Release the 8 clips.

▶ Disconnect the 2 electrical connectors.

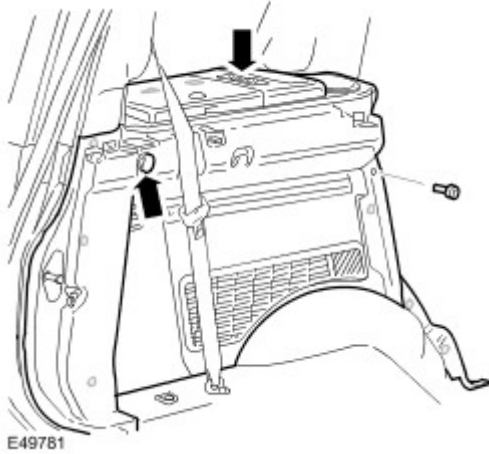

E49781

7 . NOTE:

Do not disassemble further if the component is removed for access only.

Remove the stowage tray.

▶ Release the cover.

8 . Remove the audio control switch.

▶ Release the 2 clips.

9 . Remove the accessory socket.

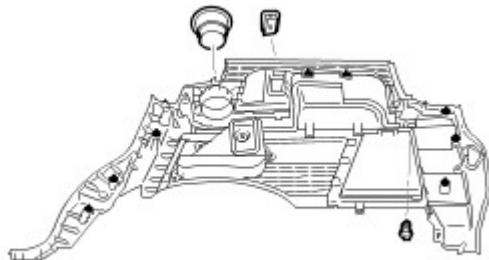

E49782

Installation

1 . Install the accessory socket.

2 . Install the audio control switch.

▶ Secure the clips.

3 . Install the stowage tray.

▶ Install the cover.

4 . Install the rear quarter trim panel.

▶ Install the clips.

▶ Tighten the Torx screw to 8 Nm (6 lb.ft).

▶ Connect the electrical connector.

5 . Install the support spigot to the tailgate.

 Install the clip.

6 . Install the tailgate aperture seal.

7 . Install the safety belt anchor.

 Tighten the Torx bolt to 40 Nm (30 lb.ft).

8 . Install the door aperture weatherstrip.

9 . Return the seat backrest to the upright position.