

2040405
04-2008
LS
P0116551-09

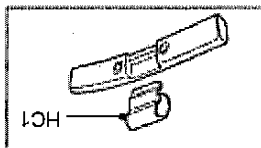

1040B



HC1

1040A



1700

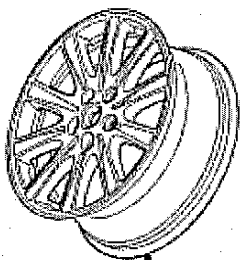

1007F

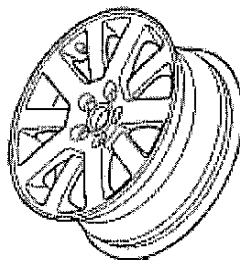

1007E

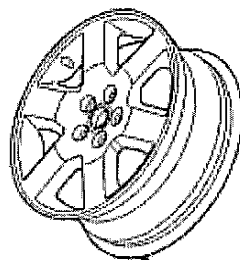

1007B

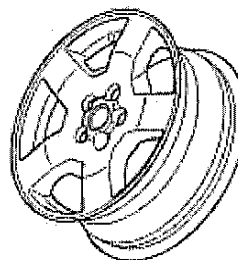

1007C

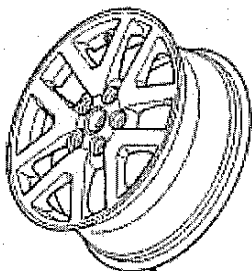

1007G

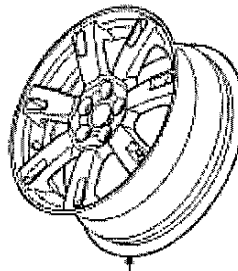

1007H

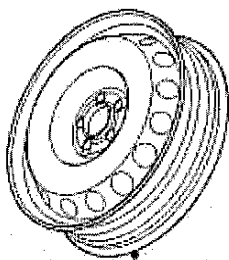

1007A

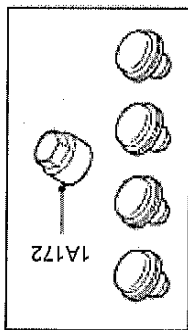

1A172

1A380

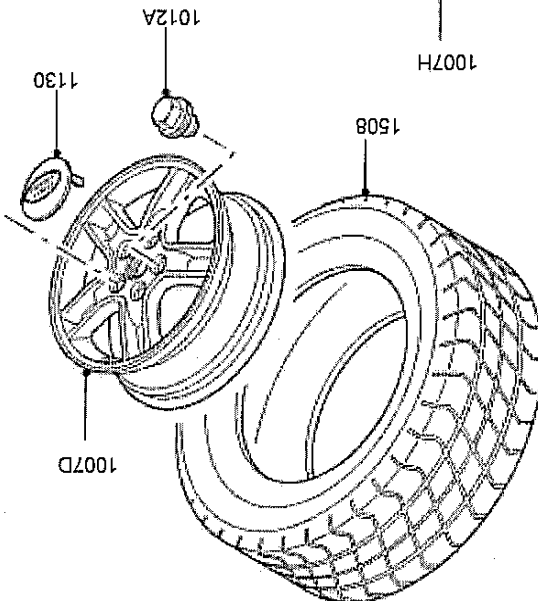

1012A

1130

1508

1007D

Fax: 086 554 3839

Att: Richard

Section: LR3/Discovery 3 (GCAT) 2005-
Catalogue: 204-04/05A WHEELS (TO (V)9A999999)

With compliments from ,